

Display flessibile e conveniente

Flexible and practical display

Il sistema con cremagliera passo 50, presenta innumerevoli vantaggi legati soprattutto alla flessibilità nei cambi del display merceologico e ovviamente alla grande affidabilità in termini di sicurezza.

The pitch 50 system presents countless advantages, especially in terms of flexibility when changing product display, as well as great reliability in terms of safety.



I pannelli di rivestimento posteriori sono sganciabili in maniera indipendente a qualunque altezza delle scaffalature, velocizzando la sostituzione del display e ottimizzando i costi del rivestimento posteriore

The back panels can be removed independently at any height, speeding up display changeover and thus optimising the costs of the back panels



La struttura F50 offre innumerevoli possibilità di configurazione "integrata" che permette l'esposizione per la vendita sulla gondola e la scorta nei livelli superiori sul rack

The F50 structure offers countless "integrated" configuration possibilities, allowing items for sale to be displayed on gondolas and stocks to be placed on the upper levels on racks



Flessibilità in sicurezza

Flexible but safe

F50



La Fortezza S.p.A.

Headquarters: Via dell'Artigiano, 23 - Pinerolo (TO)
Tel. +39 051 770611 - Fax +39 051 772608
Email: marketing@lafortezza.com



lafortezza.com



LAFORTEZZA
Industrial Store Systems

F50



La scaffalatura per la grande distribuzione organizzata è, sin dagli anni '80, il **core business** di La Fortezza, che ad oggi può vantare solide partnership con le più importanti insegne del mondo. La grande attenzione dell'azienda verso la ricerca e l'innovazione contribuisce ad un costante aumento della **gamma di accessori** e del **range di strutture speciali** per rendere la scaffalatura sempre più corrispondente alle nuove esigenze operative e logistiche.

Fittings for the retail sector has been La Fortezza's core business since the 1980s, and the company now boast a solid partnerships with the most important names in the world. The company pays particular attention to research and innovation and strives to constantly expand its range of accessories and specialised structures, adapting its shelving to new display and layout requirements.

GONDOLA | Principali componenti GONDOLA | Main components

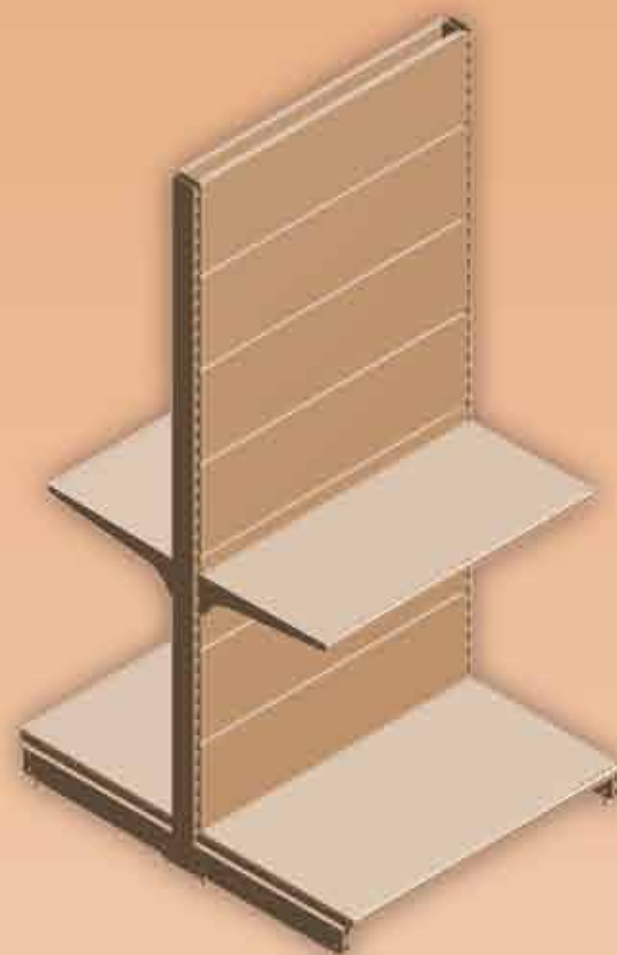

Montanti con asolatura passo 50
Pitch 50 slotted uprights

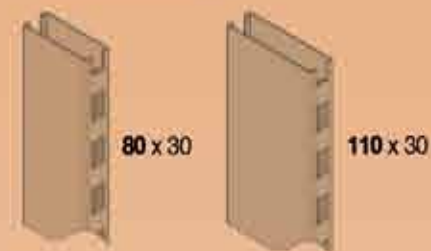

Piedi di base con 2 viti regolabili
Base feet with 2 adjustabels screws

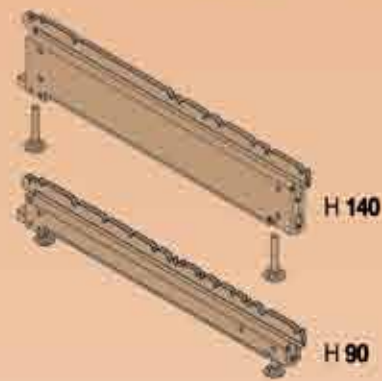

Schienale LISCIO
Plain back panel

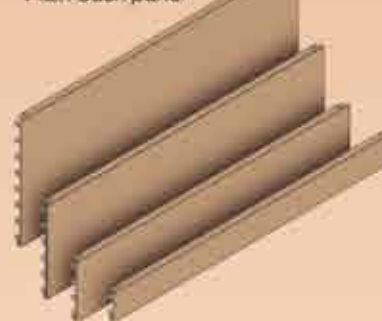

Ripiano in lamiera forata
Perforated metal sheet shelf



Ripiano in vetro temperato
Toughened glass shelf



Ripiano di base in lamiera con zoccolo integrato
Metal sheet base shelf with built-in plinth



Ripiano in filo ribassato
Lowered wire shelf



Schienale FORATO
Perforated back panel

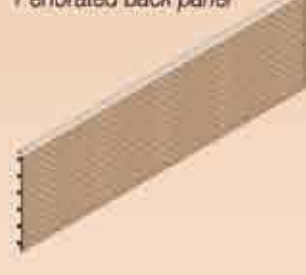

Ripiano in lamiera con alloggiamenti per set frontali e divisori
Metal sheet shelf with risers and dividers housing



Mensole a 3 posizioni
3-position brackets



Schienale MONOLAME
Monostrip back panel



SI UTILIZZA ANCHE COME ZOCCOLATURA
CAN ALSO BE USED AS A PLINTH

RACK | Principali componenti RACK | Main components



Corrente forata reversibile a seggiola 70x40
Perforated reversible stepped beam 70x40

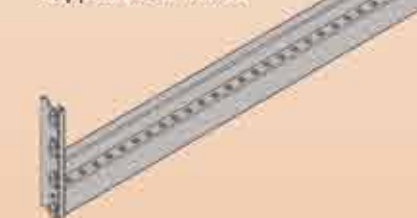

Corrente reversibile a seggiola 100x40
Reversible stepped beam 100x40

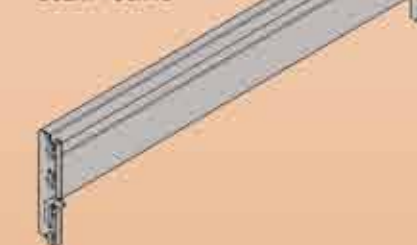

Corrente reversibile a sezione rettangolare 130x40
Reversible rectangular beam 130x40



Pianetto zincato
Galvanized shelf



Ripiano in legno
Wooden shelf

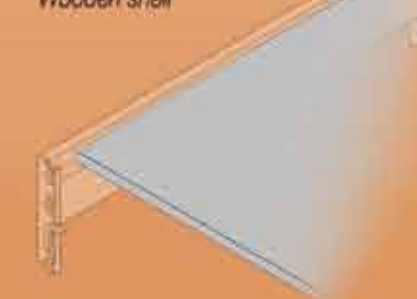

SPALLE CON TRACCIATURA PASSO 50
FRAMES WITH PITCH 50 TRACKS



Singola
Single

Singola con adattatori posteriori
Single with rear adapters

Gondola

Asimmetrica avanzata
Asymmetrical front extension